

SINCE 1901

JEFFERSON UNION COMPANY

PO BOX 5599, SALISBURY, MA 01952

369 W. MICHIGAN AVE., DELAND, FLORIDA 32720

386-626-6992 • FAX 386-626-6995 • INFO@JEFFERSONUNION.COM

TOLL FREE 888-462-5333 • WWW.JEFFERSONUNION.COM

LIST PRICE SHEET JU-25
EFFECTIVE MARCH 1, 2025

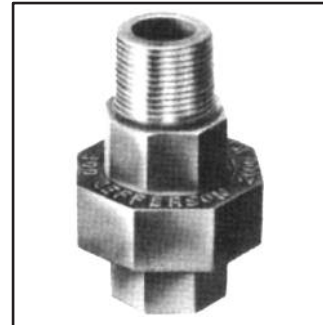

*The Standard
of Quality
for more than 110 Years...*







SINCE 1901

JEFFERSON UNION COMPANY

P.O. BOX 4420, DELAND, FLORIDA 32721-4420
 369 W. MICHIGAN AVE., DELAND, FLORIDA 32720
 386-626-6992 • FAX 386-626-6995 • INFO@JEFFERSONUNION.COM
 TOLL FREE 888-462-5333 • WWW.JEFFERSONUNION.COM

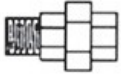
List Prices

150 POUND UNION									
BRASS TO IRON - M2 - M4 - M6 - M8 - M10*					IRON TO IRON - M3 - M5* - M7*				
STYLES		1/2	3/4	1	1 1/4	1 1/2	2		
 ALL FEMALE	M2 BLACK	13.48	15.36	20.14	28.88	36.01	41.87	—	—
	GALVANIZED	15.77	20.57	25.34	36.69	44.63	51.11	—	—
 ALL FEMALE	M3 (Iron to Iron Seat) BLACK	18.98	21.47	27.82	38.32	46.85	59.11	—	—
	GALVANIZED	23.33	26.28	35.79	46.87	57.35	72.37	—	—
 MALE & FEMALE	M4 BLACK	19.26	26.30	37.21	51.44	60.37	79.63	—	—
	GALVANIZED	20.58	28.29	39.77	54.74	65.45	86.82	—	—
 FEMALE ELBOW	M6 BLACK	46.24	54.92	67.29	94.96	123.93	162.87	—	—
	GALVANIZED	60.73	73.05	91.77	125.15	166.56	232.90	—	—
 MALE AND FEMALE ELBOW	M8 BLACK	53.32	72.69	86.57	108.67	154.24	215.83	—	—
	GALVANIZED	69.65	94.94	112.67	158.82	214.78	282.05	—	—

TOLL FREE 888-462-5333

250 POUND

BRASS to IRON - X2 - X4 - X6 - X8 - X10

IRON to IRON - X3 - X5 - X7

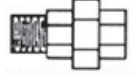
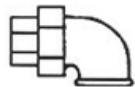
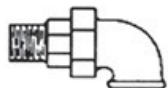
STYLES				3/8	1/2	3/4	1	1 1/4	1 1/2	2	2 1/2	3
 ALL FEMALE	X2 - X3 BLACK	—	—	18.38	21.05	25.86	41.71	49.85	54.96	—	186.12	
	GALVANIZED	—	—	23.08	27.62	31.80	50.19	59.66	73.25	—	275.27	
 MALE & FEMALE	X4 - X5 BLACK	—	—	24.18	32.53	40.45	54.16	66.96	89.12	—	—	
	GALVANIZED	—	—	26.30	35.46	44.30	68.37	70.50	92.50	—	—	
 FEMALE ELBOW	X6 - X7 BLACK	—	—	48.44	57.55	70.32	99.55	129.78	170.54	—	—	
	GALVANIZED	—	—	63.58	78.64	96.14	131.20	157.32	242.06	—	—	
 MALE AND FEMALE ELBOW	X8 BLACK	—	—	56.45	78.28	90.56	127.26	156.88	226.01	—	—	
	GALVANIZED	—	—	71.51	97.60	118.56	164.62	207.83	286.69	—	—	

300 POUND

BRASS TO IRON - J2 - J4 - J6

IRON TO IRON - J3

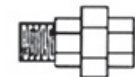
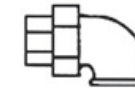
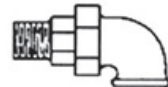
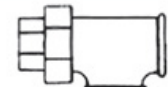
STYLES		1/8	1/4	3/8	1/2	3/4	1	1 1/4	1 1/2	2	2 1/2	3	4
 ALL FEMALE	J2 - J3 BLACK	—	—	—	23.66	26.86	35.01	56.00	58.65	74.02	—	—	—
	GALVANIZED	—	—	—	32.93	35.78	46.26	66.06	79.53	99.06	—	—	—
 MALE & FEMALE	J4 BLACK	—	28.50	—	47.33	71.52	80.19	—	—	—	—	—	—
 FEMALE ELBOW	J6 BLACK	—	—	48.02	51.59	63.58	81.39	109.08	142.22	186.78	—	—	—
 MALE AND FEMALE ELBOW	J8 BLACK	—	—	—	58.42	81.89	94.69	133.06	168.92	236.29	—	—	—
	GALVANIZED (on request)	—	—	—	—	—	—	—	—	—	—	—	—
 FEMALE TEE UNION ON RUN	J10 BLACK	—	—	—	52.30	60.93	74.57	96.16	125.02	165.79	—	—	—
	GALVANIZED (on request)	—	—	—	—	—	—	—	—	—	—	—	—

SHIPMENT OF ALL ORDERS ON ABOVE STOCK ITEMS CAN BE MADE SAME DAY ORDER IS RECEIVED.

OUR 24 HOUR FAX NUMBER (386) 626-6995

Packaging

Standard Packaging Quantities and Estimated Weights (Cartons)

150# & 250# ALL FEMALE											
SIZE	1/2	3/4	1	1 1/4	1 1/2	2					
PIECES	50	50	25	25	20	15					
POUNDS	22	34	24	38	37	43					
150# & 250# ALL FEMALE UNION ELBOWS											
SIZE	1/2	3/4	1	1 1/4	1 1/2	2					
PIECES	50	50	30	20	15	8					
POUNDS	28	39	40	41	41	31					
300# ALL FEMALE											
SIZE	1/8	1/4	3/8	1/2	3/4	1	1 1/4	1 1/2	2		
PIECES	100	100	100	60	50	25	20	15	10		
POUNDS	19	28	38	35	42	33	43	42	44		
300# ALL FEMALE UNION ELBOWS											
SIZE			3/8	1/2	3/4	1	1 1/4	1 1/2	2		
PIECES			50	40	30	20	15	10	6		
POUNDS			22	30	30	35	38	37	30		

JEFFERSON UNION - TERMS AND CONDITIONS

2% Cash Discount 10 days - net 30 days. Freight Charges prepaid and allowed on 500 lbs. or more. No responsibility can be assumed for losses, damages or delays caused by fires, strikes or contingencies beyond our control. When ordering, always give the Figure Number as shown in the catalog. Black will be shipped unless Galvanized is specified. J-Series Unions will be shipped on orders for 300 pound Unions unless otherwise specified. Orders for Engineered Specialties are not subject to cancellation after manufacture of the material has been started. We guarantee all Jefferson products to the extent that we will replace any Unions having manufacturing defects. We cannot make allowances or be responsible for labor or expense required to repair defective goods. Our responsibility in all cases is limited to the price of the defective material. When goods are delivered to carrier in good order, the carrier becomes responsible for losses or damage in transit. No claim will be allowed unless made within ten days of receipt of shipment.

Manufacturers of Malleable Iron Pipe Unions and Union Fittings Since 1901